

# NAV-TV

INTERFACING THE FUTURE

3950 NW 120<sup>th</sup> St. Coral Springs, FL 33065 TEL 561-955-9770 FAX 561-955-9760

[www.nav-tv.com](http://www.nav-tv.com) [info@nav-tv.com](mailto:info@nav-tv.com)

BHM  
12/03/19  
NTV-DOC350



## Overview

The *Smart-Link* is a smartphone interface that adds convenience features to any screen or specific NAV-TV interface kits equipped with Digital-RGB input. This module has composite and (proprietary) HD video output and can be controlled by either a 4-wire resistive touch screen (not provided), *optional* knob-controller or OEM touchscreen (if available). Analog RCA audio out is provided and must be sent to the vehicle if available via an AUX input. See full compatibility chart on page 2.

## Kit Content



Smart-Link Adapter



HDMI Cable

Touch/Video Cable

Power/Audio Cable

Microphone

BT/WIFI  
Antennas (x2)

### Optional

Control Knob  
NTV-INT311



Agreement: End user agrees to use this product in compliance with all State and Federal laws. NAV-TV Corp. would not be held liable for misuse of its product. If you do not agree, please discontinue use immediately and return product to place of purchase. This product is intended for off-road use and passenger entertainment only.

Current Compatibility\*

NAV-TV SKU	Compatible	NAV-TV KIT	MAKE	Control	AUX input
NTV-KIT749	Yes	PCM3.1N	Porsche (w/ NAV)	OEM touch	OEM 3.5mm
NTV-KIT780	Yes	GM-LVDS	CHEVY/GMC/CADDY	OEM touch	OEM 3.5mm
NTV-KIT798	Yes	IOB-RVC	CHEVY/GMC 7"	OEM touch	OEM 3.5mm
NTV-KIT837	Yes	BMW-EVO ID6	BMW	OEM touch	USB-AUX adapter
NTV-MOD031	Yes	Bentley-MOD	Bentley	OEM touch	OEM 3.5mm
NTV-KIT880	Yes	JLR-17+	Jaguar/Land Rover	OEM touch	OEM 3.5mm
NTV-KIT881	Yes	GVIF-LEX13	Lexus	OEM touch	OEM 3.5mm
NTV-KIT882	Yes	GVIF-LEX15	Lexus	OEM touch	OEM 3.5mm
NTV-KIT883	Yes	GVIF-LEX18	Lexus	OEM touch	OEM 3.5mm
NTV-KIT796	Yes	GM-GVIF	Chevy/GMC/Caddy	OEM touch	OEM 3.5mm

Interface Connectors

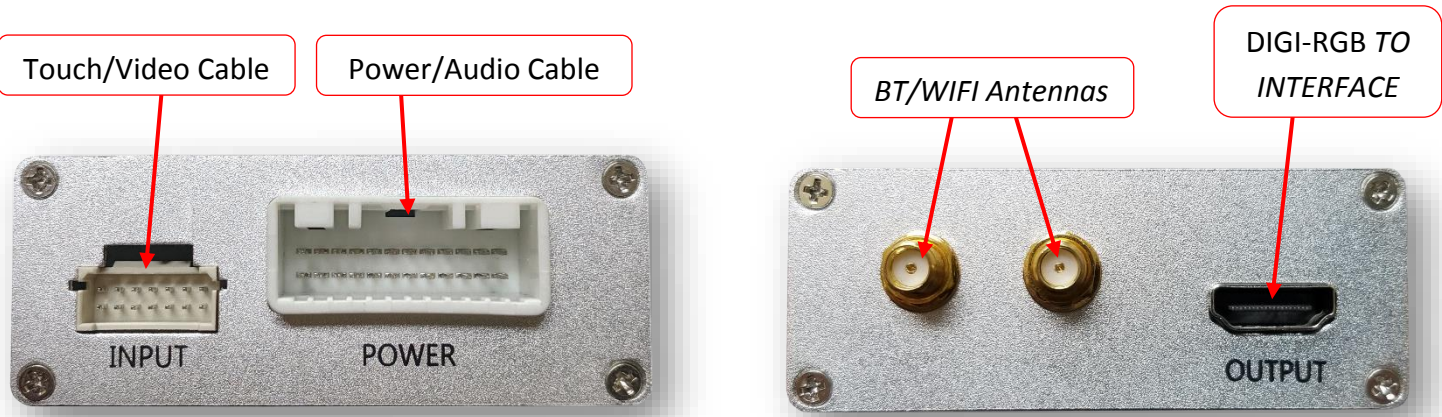

Agreement: End user agrees to use this product in compliance with all State and Federal laws. NAV-TV Corp. would not be held liable for misuse of its product. If you do not agree, please discontinue use immediately and return product to place of purchase. This product is intended for off-road use and passenger entertainment only.

## Smart-Link Installation

Smart-Link was designed to be as flexible as possible (for 12v systems) and is adaptable for use with two different screen (input) types. Below are all Input, Output & system control options available. All functions are simultaneously available.

### **General INPUT (& controlling options):**

1. 4-wire resistive touch panel ribbon input (OS has built-in calibration programming)
2. Factory touch screen via UART (HDMI connection) – vehicle specific, must be combined with an additional NAV-TV module for best functionality (see chart pg 2) **NOTE: if touch does not function over HDMI cable, you must use the provided TOUCH (ribbon cable) connection to the interface (provided with interface kit).**
3. Controller knob (custom fabrication recommended for best result)
4. Microphone (for BT phone calls & controlling SmartPhone via specific voice commands)
5. Camera input (only used in a universal application – ie, no source unit switching is available)

### **General OUTPUT (AV output):**

1. Low resolution composite video (yellow RCA)
2. High definition Digi-RGB (HDMI connection – connects to proprietary NAV-TV module, see chart pg 2)
3. Low-Level Audio stereo output (red & white RCAs) – global audio output – connects to AUX input (NOTE: Installer is

### **Power Connections:**

1. Black wire: connect to ground (-)
2. Yellow wire: connect to constant 12v (+)
3. Red wire: connect to ACC 12v (+)

### **Other required connections:**

1. Once you have good secure placement for the Smart-Link device, connect the provided BT and WIFI antennas to the ports on the side of the unit and try to stick the antenna side as close to the passenger compartment as possible, preferably with no metal is blocking the antenna (from smartphone). **NOTE: these antennas are the same and therefore can be connected to either port.**
2. Audio output should be determined by the installer – the Smart-Link unit provides global low-level audio output via Red & White RCAs, connect to an existing vehicle AUX input (may require adapter). **NOTE: if no AUX input is available, contact NAV-TV for options.**
3. Follow one of the connection guides on pages 4-6 choosing input & output type for control and video.





Smart-Link diagram: Global Usage

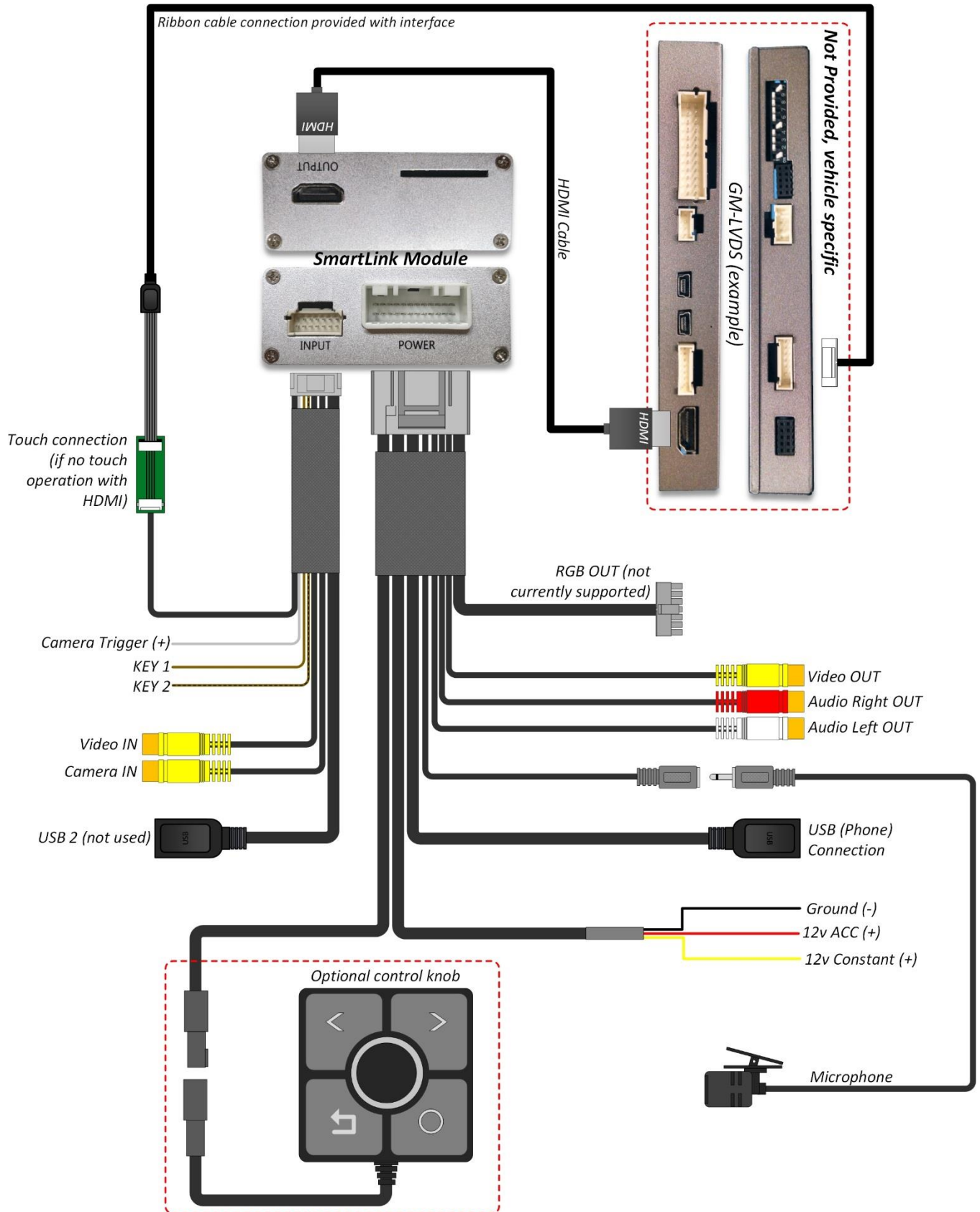

Agreement: End user agrees to use this product in compliance with all State and Federal laws. NAV-TV Corp. would not be held liable for misuse of its product. If you do not agree, please discontinue use immediately and return product to place of purchase. This product is intended for off-road use and passenger entertainment only.

Smart-Link diagram: (touchscreen overlay)

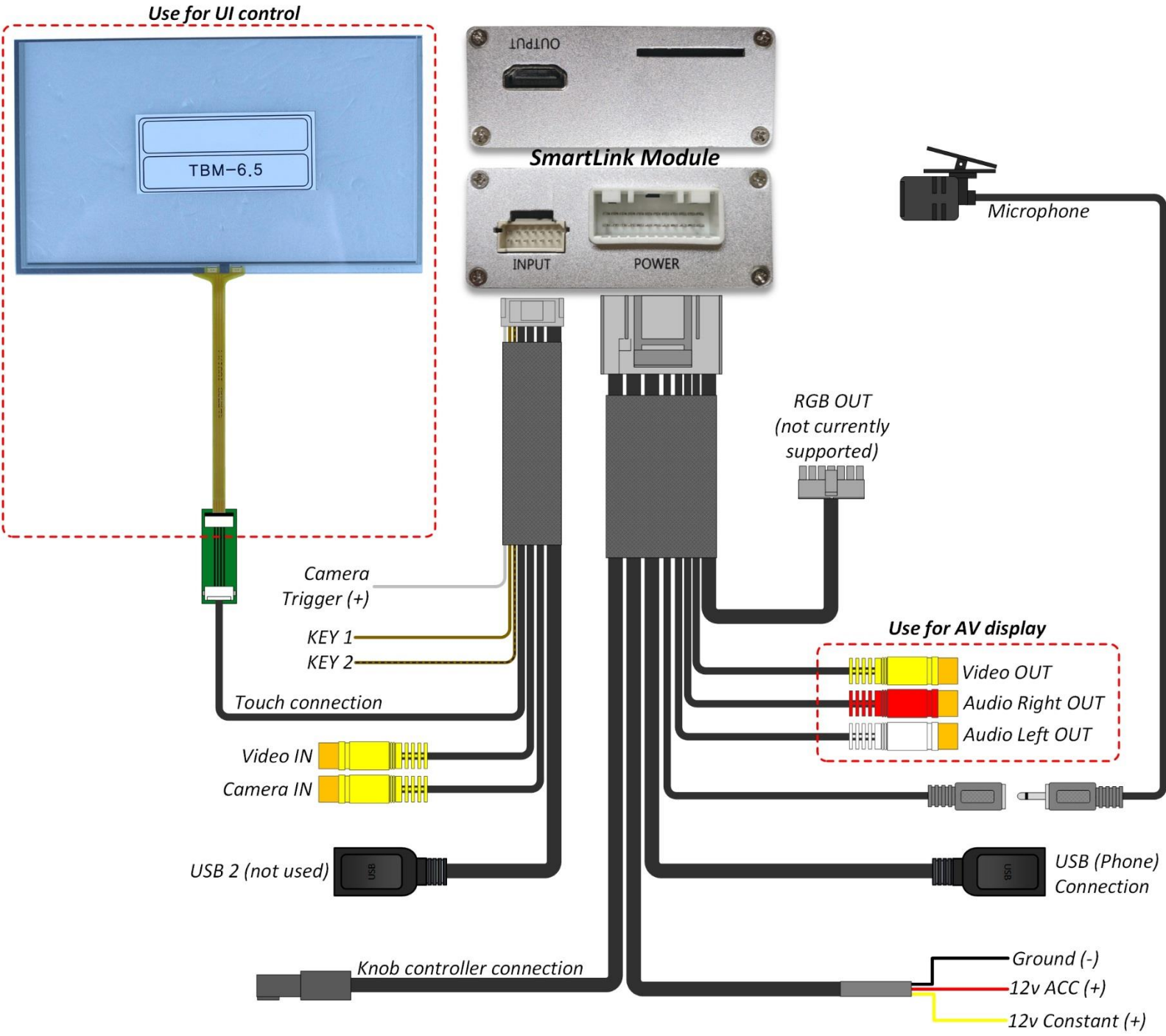

Agreement: End user agrees to use this product in compliance with all State and Federal laws. NAV-TV Corp. would not be held liable for misuse of its product. If you do not agree, please discontinue use immediately and return product to place of purchase. This product is intended for off-road use and passenger entertainment only.

Smart-Link diagram: (knob controller)

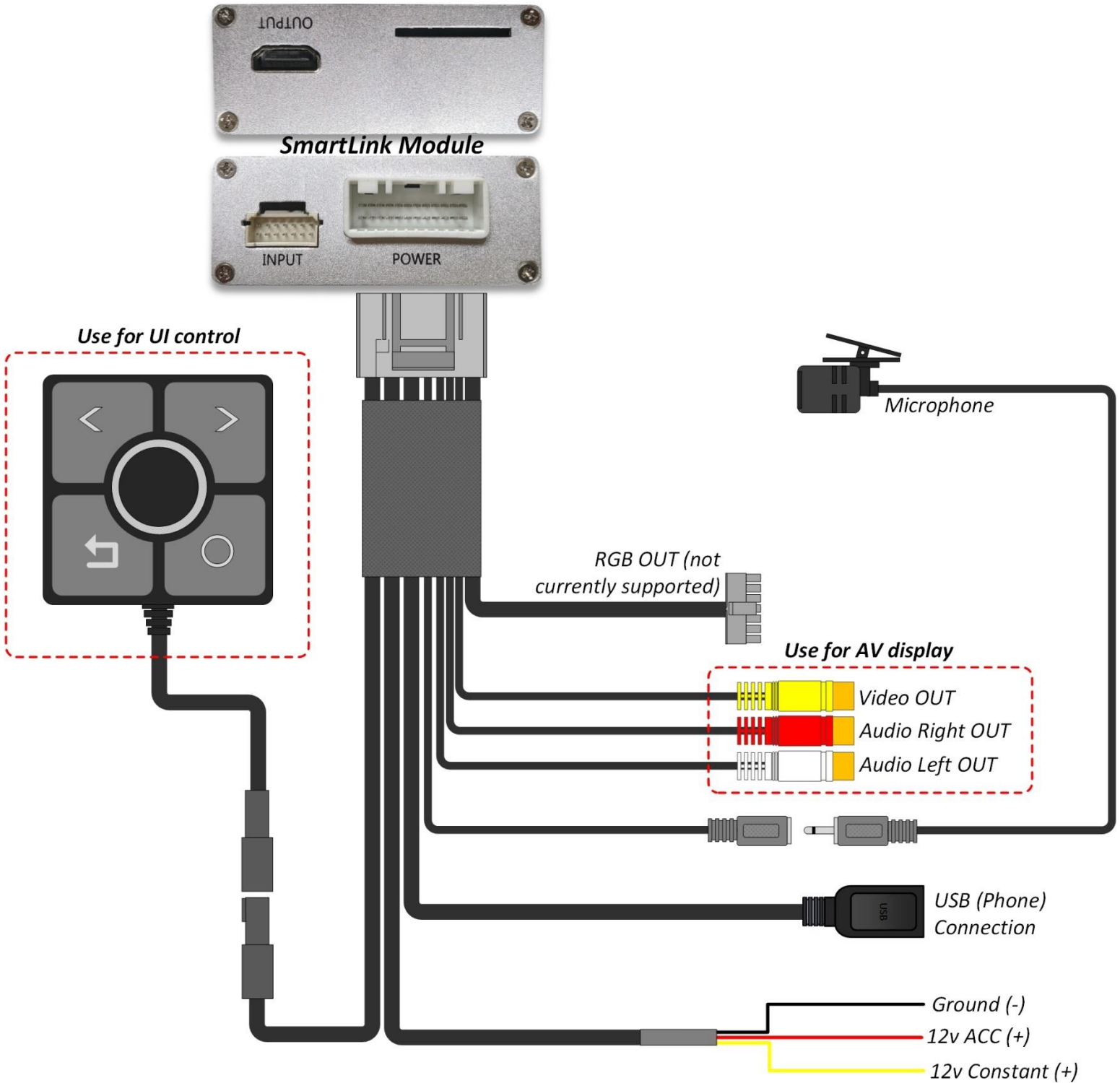

Agreement: End user agrees to use this product in compliance with all State and Federal laws. NAV-TV Corp. would not be held liable for misuse of its product. If you do not agree, please discontinue use immediately and return product to place of purchase. This product is intended for off-road use and passenger entertainment only.

## Interface setup for Smart-Link (compatible NAV-TV interface)

If using the Smart-Link in conjunction with a compatible NAV-TV interface, the UI control is over **factory touchscreen** and the Video is sent via **DIGI-RGB** (via HDMI cable). **Audio output** from the Smart-Link module must be connected to the vehicle AUX input. If no AUX input is available, contact NAV-TV for options. Follow the instructions below to set up the NAV-TV interface for proper communication with the Smart-Link.

To begin, follow the instructions on the compatible NAV-TV interface for proper installation. Connect the provided HDMI cable from the **OUTPUT** port on the Smart-Link to the **DIGITAL-RGB IN or LVDS-IN** port (HDMI) on the interface.



- Follow the steps below to set up the **Interface** for Smart-Link connection:

- With the system on, put dip switch #1 in the **DOWN** position.
- Activate the 'NAV INPUT' by pressing the proper button on the steering wheel or dash (see interface manual, 'operation')
- Once 'NAV INPUT' shows on the screen, on the provided remote press the **OK BUTTON 4 times**, then press **POWER** (after connecting IR receiver).
- Navigate to the 'NAVI' section.
  - Select 'NAVI-SEL' (OK button)
  - Choose 'HD-G2' or 'N700' (up or down arrow, then OK to select)
  - Press **MODE** on the remote to return and exit the OSD menu (or let it time out).

- Once complete, pressing the OEM button assigned for AV switching (button to switch to cycle AV sources – see interface manual) will activate the Smart-Link, and repeating the same action will return to the OEM screen.

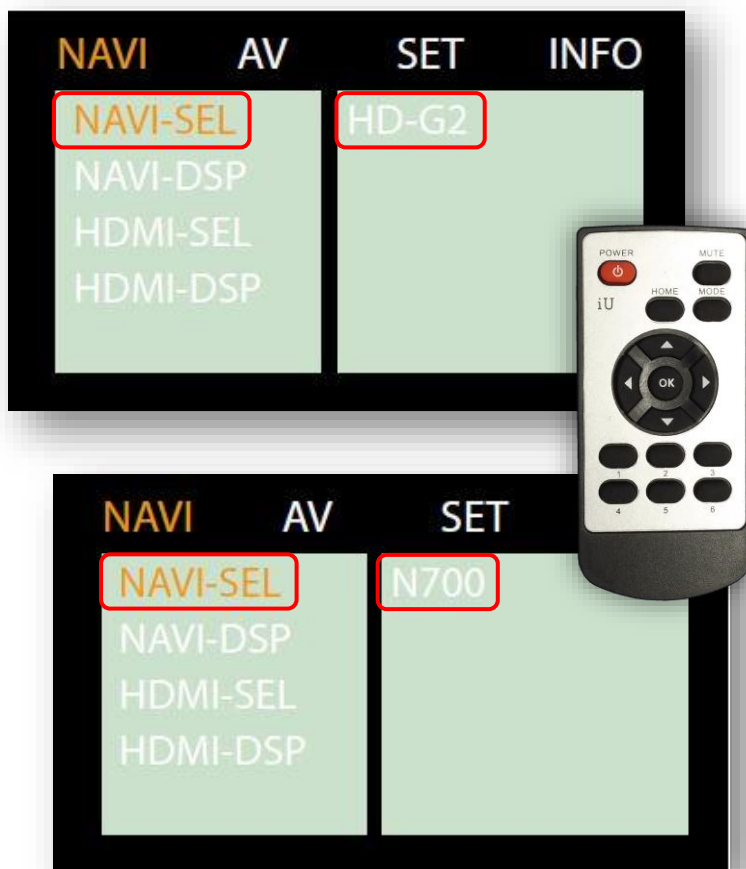

## Smart-Link Menu Options

The Smart-Link has many options for configuring hardware preferences. Exit the Phone OS system by selecting the 'HOME' or 'EXIT' tile, this will bring you to the main hardware OS screen. Scroll all the way to the right side and choose the 'SETTING' tile to access the settings menu.

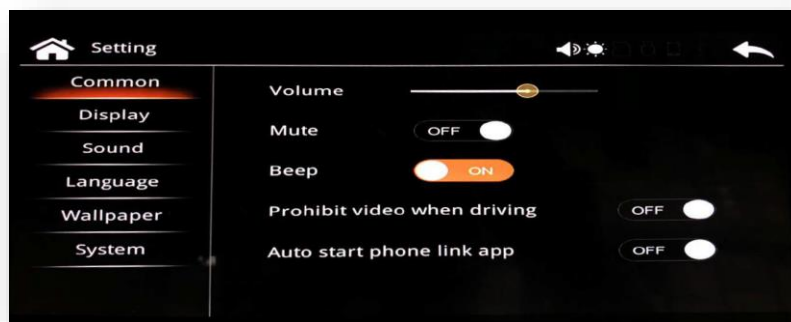

Once in 'SETTING', choose 'SYSTEM', then 'FACTORY MODE'. The passcode is '0000', then press 'OK'.



Inside 'FACTORY MODE' there are options for control like touchscreen calibration or boot-logo. **NOTE:** *alternatively, you may calibrate the touchscreen by exiting to the main OS (or disconnect any phone connected), press and HOLD the touchscreen for 15 seconds and calibration crosshairs will appear.*

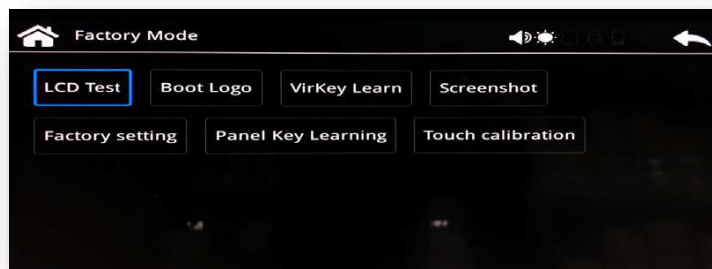

Inside 'FACTORY SETTING', there are options for advanced control like Wireless vs wired link type, aspect ratio, right-hand driving, etc.

### NOTES:

- Upon connection to smartphone, Bluetooth and GPS must be enabled and active on the handset.
- The Smart-Link is recommended as an all-or-nothing solution, it is not suggested to try and use both OEM Bluetooth (if available) simultaneously with this module.
- When using Smart-Link Bluetooth connection for telephony, you must be in AUX mode to have a conversation (AUX must be enabled for **any** audio feedback from Smart-Link)